

Installation and operating manual

SILVER-STEAM[®]

Luxury version with stainless steel tank

DG-3



Control panel
flush-mounted
(option)

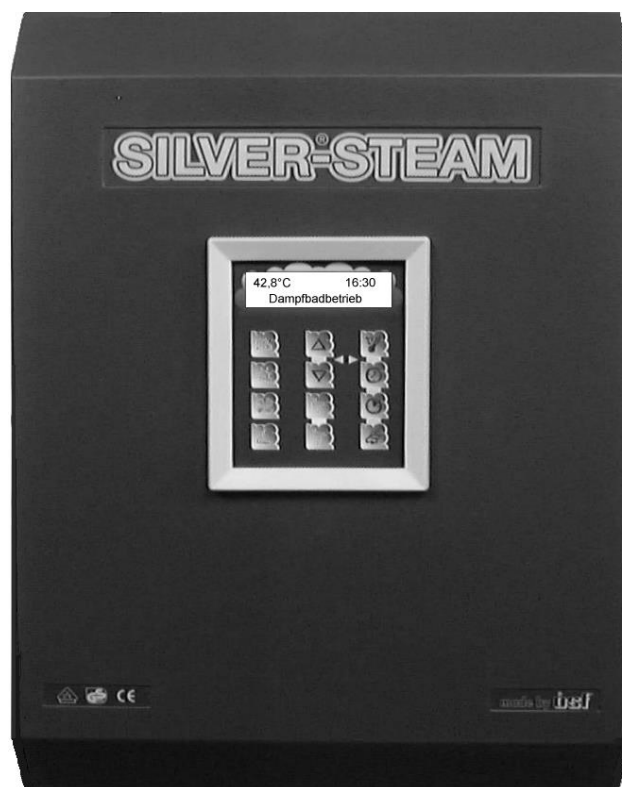

Control panel
surface-mounted
(option)

Specifications:



Nominal voltage	3/N/PE/ 400V/50Hz
Power output	max. 9kW
Temperature control range	+30°C to +50°C
Protection class	IP 40
Water feed	2 to 5 bar
External operation panel	5V
Computer interface	USB and RS485
Temperature sensor	Semiconductor
Lighting	230V or 11,5V
Exhaust fan	230V
Feed air fan	230V
Drain	Ø 20mm (outside)
Housing dimensions	ca. 580 x 435 x 240
Steam outlet	Ø 35mm (outside)
Water connection	R ¾ " thread
Filling connection for decalcifier	½ " SW 23

Type overview SILVER-STEAM

↓	Type	Power output	Lighting transformer	Metering pump	Item No.:
	L-3.0	3.0 KW			3198000030
	L-3.0+Light	3.0 KW	✓		3198100030
	L-3.0+Pump	3.0 KW		✓	3198000130
	L-3.0+Light/Pump	3.0 KW	✓	✓	3198100130
	L-4.5	4.5 KW			3198000045
	L-4.5+Light	4.5 KW	✓		3198100045
	L-4.5+Pump	4.5 KW		✓	3198000145
	L-4.5+Light/Pump	4.5 KW	✓	✓	3198100145
	L-6.0	6.0 KW			3198000060
	L-6.0+Light	6.0 KW	✓		3198100060
	L-6.0+Pump	6.0 KW		✓	3198000160
	L-6.0+Light/Pump	6.0 KW	✓	✓	3198100160
	L-9.0	9.0 KW			3198000090
	L-9.0+Light	9.0 KW	✓		3198100090
	L-9.0+Pump	9.0 KW		✓	3198000190
	L-9.0+Light/Pump	9.0 KW	✓	✓	3198100190

Contents

<u>Specifications:</u>	1
<u>Type overview SILVER-STEAM</u>	2
<u>Function</u>	4
<u>Commissioning</u>	4
<u>Displays and controls:</u>	4
<u>Display</u>	5
<u>Operating the steam generator</u>	6
<u>Setting the time</u>	6
<u>Switching steam production on/off</u>	6
<u>Temperature regulation</u>	6
<u>Timer</u>	6
<u>Odour intensity</u>	7
<u>Info key</u>	7

<u>Info key blinks</u>	7
<u>Decalcification timer</u>	7
Switching between languages	8
<u>External operating panel (optional)</u>	8
<u>External Control Panel Flush-Mounting (Option)</u>	9
<u>Rinse program</u>	10
Program sequence	10
<u>Continuous steam generator operation</u>	10
<u>Exhaust fan</u>	10
<u>Feed air fan</u>	10
<u>Coin-operated timer</u>	11
<u>Remote switch</u>	11
<u>Adjusting water hardness</u>	12
<u>Drainage connections</u>	13
<u>Installation:</u>	13
<u>Electrical power supply / safety information:</u>	13
<u>Connection to water supply</u>	14
Service information: 	14
<u>Ventilation:</u>	14
<u>The steam pipeline</u>	15
Steam pipeline connections	15
Installation of the steam pipeline	15
<u>The  steam nozzles (set)</u>	16
<u>Temperature sensor installation</u>	17
Installation:	17
Course of action:	17
<u>Cubicle lighting</u>	19
Electrical connection	19
Fusing	19
External transformer	19
<u>Winter operation</u>	19
<u>Decalcification</u>	20
Course of action:	20
Completion of decalcification:	20
<u>Odour metering</u>	21
Odour intensity	21
Bleeding the fragrance hose.....	21
Connecting the fragrance unit.....	22
Fragrance metering pump maintenance	22
Course of action	22
<u>Troubleshooting checklist for malfunctions</u>	23
Troubleshooting / pilot light	24
<u>Service terminal</u>	25
<u>Circuit diagram</u>	30
<u>Wear parts</u>	30

Function

This high-quality fully automatic steam generator produces steam for steam bath cubicles. All necessary control and operation functions can be carried out using both the steam generator operating pile and the external operating panel (optional).

The comfortable  microprocessor control system takes over all necessary regulation, control and checking functions.





- Filling steam vessel with water.
- Automatic refilling of used water.
- Freshening of water for improvement of water quality.
- Monitoring and regulation of temperature in steam bath cubicle.
- Drainage of steam vessel.
- Cleaning of steam vessel and level sensor.
- Automatic control of exhaust air ventilator.
- Automatic control of feed air ventilator.
- Automatic fragrance metering (optional).







Provision of low voltage safety circuit (12V) for lighting (optional).

Commissioning

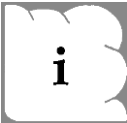
The steam generator must be adjusted to suit the hardness of the water supply before initial startup. You can find more information in the section entitled "Setting the water hardness".

Displays and controls:

	" <i>Steam</i> " key The steam generator is keyed on and off with this key.
	" <i>Light</i> " key The cubicle lighting is keyed on and off with this key.
	" <i>Ventilator</i> " key The exhaust fan is keyed on and off outside the operating time using this key.
	" <i>Fragrance</i> " key The fragrance metering is keyed on and off with this key.

	<p>"Aux" key</p> <p>This key can be used to key additional devices such as vestibule lighting, vestibule ventilation, music systems etc on and off.</p>
	<p>"i" key (Info key)</p> <p>This key can be used to call up or program information such as device type, operating hours, program version, decalcification timer, language etc.</p>
	<p>"Temperature" key</p> <p>After this key is pressed, the the wording <i>Temperature</i> and <i>Set temperature</i> is displayed. These can be changed using the <i>Plus</i> or <i>Minus</i> keys.</p>
	<p>"Clock" key</p> <p>The wording <i>Timer</i> appears in the display after this key is pressed. The time can be changed using the <i>Plus</i> or <i>Minus</i> keys.</p>
	<p>"Timer" key</p> <p>The wording <i>Timer ON</i> appears in the display after this key is pressed. The timer on time can be changed using the <i>Plus</i> or <i>Minus</i> keys. If you press the key again, the display shows the wording <i>Timer OFF</i>, which can also be changed as above.</p>
	<p>"Odour intensity" key</p> <p>The wording <i>Odour impulse</i> appears in the display after this key is pressed. The impulse time can be changed using the <i>Plus</i> or <i>Minus</i> keys. If you press the key again, the display shows the wording <i>odour pause</i>, which can also be changed as above.</p>
	<p>"Plus" key</p> <p>Use this key to increase the value during programming (e.g. time).</p>
	<p>"Minus" key</p> <p>Use this key to reduce the value during programming (e.g. time).</p>

Display

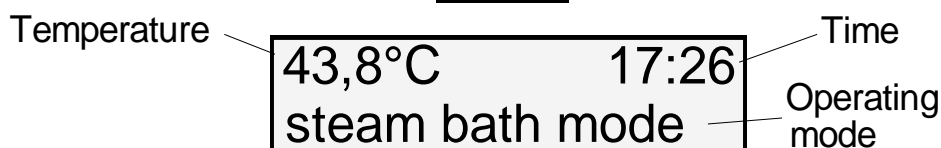

Operating the steam generator

When the steam generator is switched off, the display shows the time.

17:26

Setting the time

If you press the "Time" Key, the wording "Time" is shown in the display. The time displayed can now be changed using the *Plus* or *Minus* keys.

The time shown in the display is saved automatically. Once the time has been programmed,

36,4°C	17:26
time	

you can press the "Time" key again to return the display to the "initial position" If not, the intelligent microprocessor control system switches the display back to the initial position 10 seconds after the last time the "Plus", "Minus" or "Time" keys were pressed.

Switching steam production on/off

Steam production is switched on using the "Steam" key. Once started, the display shows the time, cubicle temperature and the wording "Steam bath mode". After switching on, any residual water

46,4°C	17:26
steam bath mode	

which might have accumulated in small quantities is pumped out, the fresh water feed is opened and the steam vessel is filled with water. Once the required water level has been reached, the water feed is automatically stopped and the water starts heating. A few minutes will pass before the actual steam production commences depending on the capacity of the steam generator. Any water used during operation is automatically refilled. The intelligent **ISI** microprocessor control system monitor steam production continuously and ensures problem-free operation. Small quantities of water are occasionally replaced with fresh water depending on the thermal output, steam production, water consumption and other factors. If required, the microprocessor control system will automatically switch the exhaust fan (if fitted) on and off to improve room climate. When operation has finished, the steam generator is switched off using the "Steam" key mentioned above, and the rinse program is then automatically activated. Once the rinse program has completed, the steam generator switches off automatically. The water container is then empty.

Temperature regulation

If you press the "Temperature" key, the display shows the set temperature (required temperature), and the wording "Temperature" is shown in the display. The displayed temperature (required temperature) can be individually

38,1°C	17:26
set temperature	

changed using the "Plus" or "Minus" keys. Settings can be made between 30°C and 50°C. **The temperature shown in the display is automatically saved.** Once the temperature has been programmed, press the "Temperature" key again to switch the display back to the "initial position". If not, the intelligent microprocessor control system switches the display back to the initial position 10 seconds after the last time the "Plus", "Minus" or "Temperature" keys were pressed.

Timer

You can use this function to switch the steam generator on or off automatically. If you press the "Timer" key, the wording "Timer ON" is shown in the display. The timer on time displayed can now be changed using the *Plus* or *Minus* keys.

10:00
on-switch time

The time shown in the display is saved automatically.

Now press the "Timer" key again, and the display will show the wording "Timer OFF". Press the "Plus" or "Minus" keys to change the timer off time displayed. **The time shown in the display is saved automatically.**

20:30
off-switch time

Once the timer has been programmed, press the "Timer" key again to switch the display back to the "initial position". If not, the intelligent microprocessor control system switches the display back to the initial position 10 seconds after the last time the "Plus", "Minus" or "Timer" keys were pressed. **If you do not want to switch the steam generator on or off automatically, enter the same times for the switch-on and switch-off values** e.g: Time ON 16:00, Time OFF also 16:00.

Odour intensity

Use this function to program the odour intensity. If you press the "Odour intensity" Key, the wording "Odour impulse" is shown in the display. The impulse length displayed can now be changed using the Plus or Minus keys. Increasing the impulse length results in longer operation of the odour metering pump and therefore an increase in odour intensity. **The value shown in the display is automatically saved.**

Seconds
01,0
odour impulse

Now press the "Odour intensity" key again, and the display will show the wording "Odour pause". Press the "Plus" or "Minus" keys to change the pause length displayed. Increasing the pause length results in a longer pause between odour injections and therefore reduction of odour intensity.

The time shown in the display is saved automatically. When you are finished programming the odour intensity, press the "Odour intensity" key again to return the display

Seconds
Minutes
05:20
odour pause

to the "initial position". If not, the intelligent microprocessor control system switches the display back to the 10 seconds after the last time the "Plus", "Minus" or "Odour intensity" keys were pressed.

Info key

If you press the  key, the following messages are shown in the display:

Programm version
i osf DG3 v.1.00
SN: 1234 9,0 kW
Serial number
Power output

Info key blinks

If the pilot light in the Info key is blinking, the decalcification timer has responded (see decalcification timer). The steam generator must now be manually decalcified.

Decalcification timer



If the  key is pressed twice, the following messages are shown in the display:

Operating hours since last decalcification
i / decalcify
90h / 100h >90%

An acoustic signal is sounded when the steam generator is switched on once a decalcification cycle has been completed. In addition, the display shows the wording "Please decalcify". The steam generator must now be decalcified. You can find more information in this section entitled "Decalcification".

Decalcification cycle

The timer needs to be reset as follows once decalcification has been completed:







1. Press  key twice
2. Press  key
3. Press  key

The decalcification timer has now been deleted. You can now use the steam generator as usual. If the "Please decalcify" message is shown in the display again, you must decalcify the steam generator again.

Switching between languages

If the  key is pressed three times, the following messages are shown in the display:

The language can now be selected as follows

1. Press  key or  key. Another language is now shown in the display.
2. Press  key or  key again, until the required language is shown in the bottom display line.
3. Press the  key to activate the language shown in the display. Save the language displayed by pressing the  key.

i	language:	D
	german	D

Currently selected language

The following languages are available:

German, English, French, Danish, Dutch, Spanish, Italian, Polish, Hungarian, Czech.



Time reserve

The digital clock has a time reserve. Any data programmed for the set temperature, timer and fragrance interval control are saved permanently even after the time reserve is used up.

External operating panel (optional)

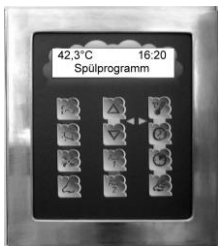
Ext. operating panel



The  SILVER-STEAM luxury steam generator can be operated using an **external operating panel** (flush or surface-mounted). This operating panel has the same functions as the built-in operating panel. All necessary switching and programming functions can be carried out using the external operating panel. The display also shows the time, temperature, operating conditions and service information. This makes problem-free operation and control of the steam bath possible using a remote control. A 4-core screened cable is necessary for an electrical connection with the steam generator, which can be ordered from .

Circuit diagram

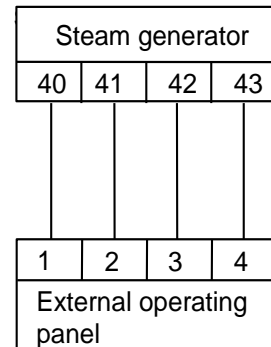

This **connecting cable must not be longer than 30 metres**. You should avoid routing this cable near power cables to prevent possible interference. The external operating panel may not be mounted inside the steam bath cubicle.

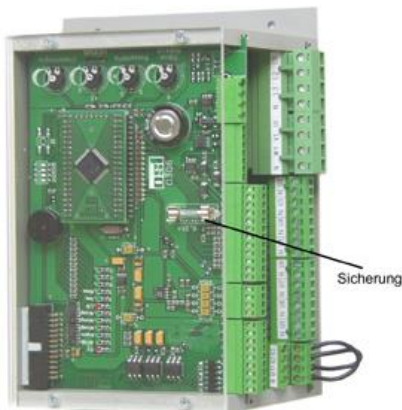

Fusing

The top PCB is fitted with a 0.25 mA fuse to protect both external and internal operating panels.

Housing with both electronic circuit boards

External Control Panel Flush-Mounting (Option)

The control panel has been designed to be flush-mounted by means of the delivered tile frame. An installation inside a steam bath cabin is not possible.

The mounting of the tile frame is carried out by the tiler during the tile laying process.

- 1.) Prepare tile frame:

Bend the four mounting straps backwards and then outwards.

Tile frame

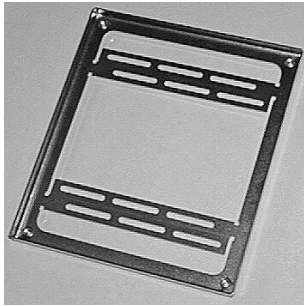

Bend mounting straps backwards

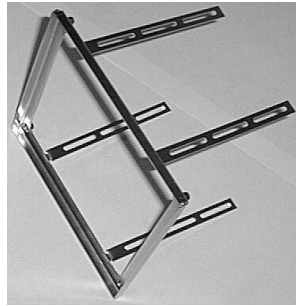

Bend mounting straps outwards

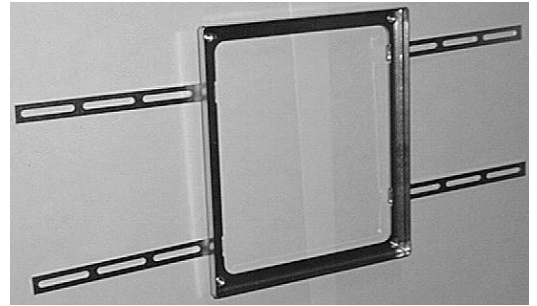

- 2.) At the place on the wall where the control is to be installed, work out a space for the casing.
- 3.) Adjust the tile frame in front of the place on the wall in the following way:
 - horizontally
 - vertically
 - ***the front edge of the tile frame must be flush with the tiles!***
- 4.) Fix the mounting straps on the wall by means of screws or nails and fix it with mortar or tile cement.
- 5.) Lay the tiles direct unto the outer edge of the tile frame.

Mounting the - control panel into the tile frame

The control panel is mounted into the tile frame by an electrician after the wall has been laid with tiles and grouted.

- 1.) Lead the connecting cable through the screwed cable gland and finally tighten the pressure screw of the screwing. The bush must be water-proof.
- 2.) Insert the metal casing into the tile frame and fix it with the provided 4mm stainless steel screws. One screw each is screwed into the four edges.
- 3.) Connect the cable to the operating panel as per the operating instructions. The clamps are located on the back of the board.
- 4.) Insert the operating panel into the casing and tighten it on the metal frame with the screws provided. Please screw in all screws to prevent penetrating water. The seal must not be damaged.
- 5.) Carefully place the cover frame with the magnetic holding. On doing so the magnets must grip into the recesses of the board.

Rinse program

The  SILVER-STEAM steam generator is provided with a standalone rinse program as standard. This rinse program frees important steam generator components of deposits by cleaning the complete heating system and safety equipment. The service life of the entire device is considerably lengthened, and service costs are reduced, thanks to this installation. **This rinse program is necessary for interference-free and reliable operation of the steam bath, and may therefore not be suppressed or interrupted.**

Program sequence

Once the steam generator has been switched off using the key provided, the wording "*cleaning system*" appears in the display. At the same time, a delay of one minute occurs. If the

48,1°C	19:20
cleaning systeming	

steam generator is switched on within this minute, steam production will continue. ⇒ **The cleaning program is not started**, and the display returns to the initial setting.

Cleaning of the equipment starts after the one minute delay has elapsed. The system is emptied, then rinsed through twice with fresh water, and then emptied again. At the end of the cleaning program, the steam generator is automatically switched off and is then ready for later operation. The water container is empty when the steam generator is switched off.

The water or power feed may not be interrupted during the program sequence.

If the "*Steam*" key mentioned above is pressed during the program sequence, this **does not interrupt the cleaning program**. The steam vessel is only filled with water so that steam production can begin once the cleaning program has completed.

Continuous steam generator operation

If the steam generator is not switched off once the key provided is pressed, the rinse program cannot be started. In this case, the intelligent  microprocessor control system switches the rinse program on automatically. The switch-on time is controlled by the steam generator thermal output, the size of the cubicle, water consumption, cubicle temperature and other factors. Steam production will be interrupted as a result of this unavoidable system cleaning.

Exhaust fan

The exhaust fan is switched on and off automatically when the steam generator is switched on by the microprocessor control system, and cannot be influenced externally. The exhaust fan can be switched on manually using the "*Fan*" key on the operating panel outside steam bath operating times. Once the steam generator has been switched off, the exhaust fan is switched on automatically for 10 minutes to ventilate the steam bath cubicle.

Feed air fan

The feed air fan is switched on automatically when the steam generator is switched on. It is switched off automatically a few minutes after the steam generator has been switched off. Once the steam generator has been switched off, the feed air fan is switched on automatically for 10 minutes to ventilate the steam bath cubicle.

Coin-operated timer

A coin-operated timer can be connected to terminals 60, 61, U10 and N on the electronic control system. The generator remains at standby status until a coin is inserted. The water is heated but no steam is produced. As soon as a coin is inserted, steam production starts immediately. If no coin-operated timer has been connected, a bridge must be inserted across terminals 60 and 61, as well as U10 and N (as supplied). **The generator still needs to be switched on and off using the switch provided, or the integrated timer, even if operation is controlled by a coin-operated timer.**

Coin-operated timer with 230V output	Coin-operated timer with floating output	No coin-operated timer connected
<p>Steam generator</p> <p>N U10 60 61</p> <p>N L1</p> <p>Coin-operated timer</p>	<p>Steam generator</p> <p>N U10 60 61</p> <p>Coin-operated timer</p>	<p>Steam generator</p> <p>N U10 60 61</p> <p>Two bridges are inserted as supplied</p>

Remote switch

A remote switch (external switch) can be connected to terminals 62, 63, U11 and N on the electronic control system. The steam generator can be switched on and off using this remote switch. The rinse program starts when the device is switched off.

Remote switch with indicator lamp	Remote switch without indicator lamp	No remote switch
<p>Steam generator</p> <p>N U11 62 63</p> <p>N L1</p> <p>Remote switch</p>	<p>Steam generator</p> <p>N U11 62 63</p> <p>Remote switch</p>	<p>Steam generator</p> <p>N U11 62 63</p> <p>If no remote switch is connected, the terminals remain unused.</p>

Adjusting water hardness

Adjustments must be made to the electronic control system for water hardness during the steam generator initial startup. The trade offers suitable measuring devices for determining the water hardness. The local water supply company can also normally state the water hardness on request.

Water hardness adjustment is an aid to the device operator which is intended to help decide the time of decalcification. The steam generator should be decalcified as required, normally after every 100 operating hours, irrespective of the decalcification timer.

Any service and maintenance work may only be carried out by an authorised electrician on a voltage-free device.

The water hardness is stated in degrees on the German hardness scale (°dH). In addition, water has been divided into the following hardness ranges:

Hardness range	Description	Hardness in °dH	Hardness in mmol/l
I	soft	to 7	to 1.25
II	medium	7-14	1.25-2.50
III	hard	14-21	2.50-3.75
IV	very hard	above 21	above 3.75

Adjuster for water hardness

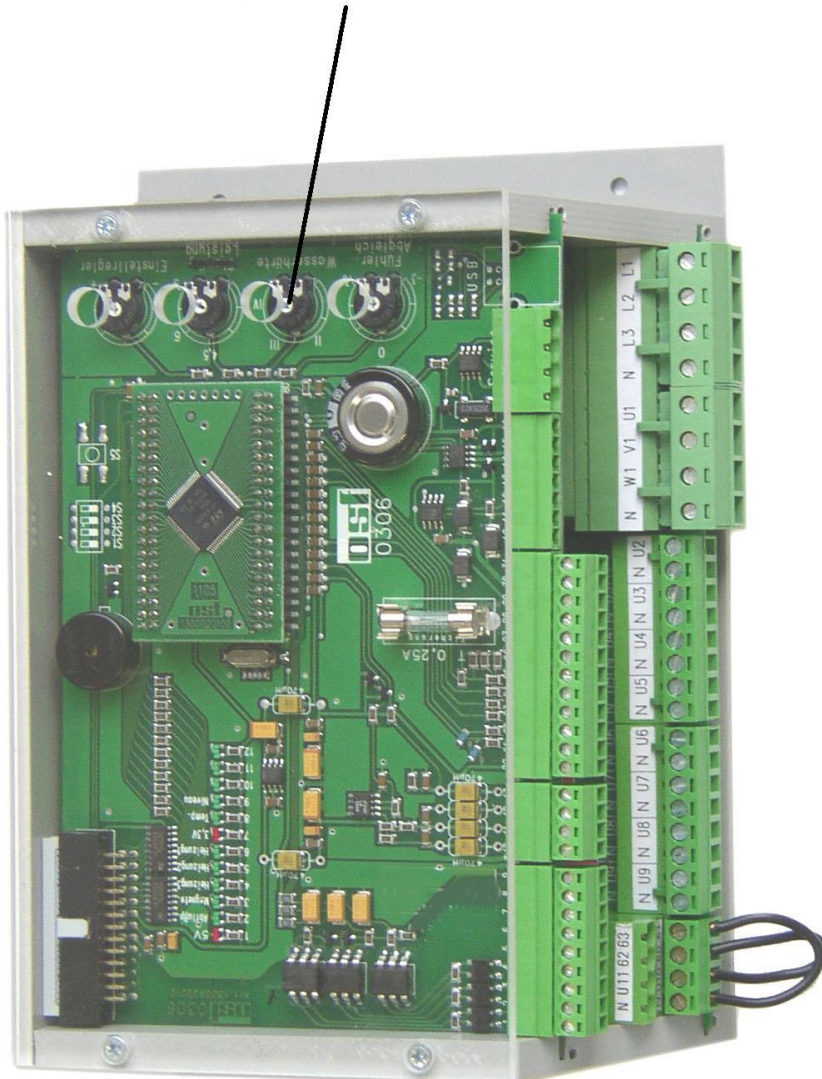

The water hardness is set at the appropriate adjuster using a small screwdriver.

The hardness ranges can be seen on the scale above the adjuster.



Adjuster

Drainage connections

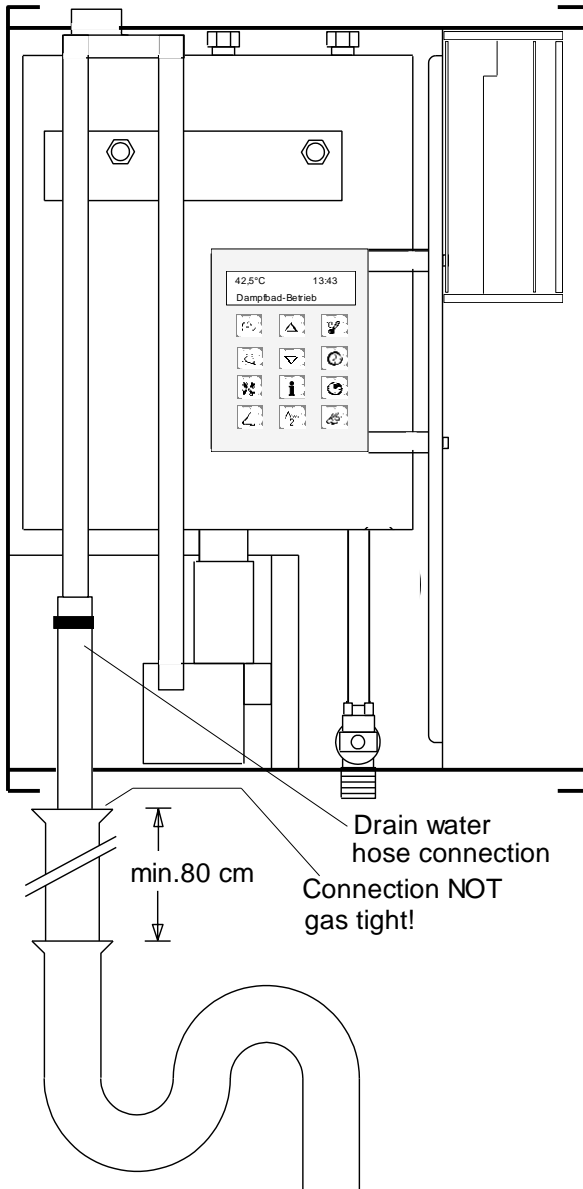

The drainage connection takes place using the supplied hose connected to the left-hand pipe end (see sketch). The connection is made fast using a hose clip. This hose is used to make the connection to the drainage pipe on site.

The connection between the flexible hose and the fixed DN 50 pipe may not be made gas tight so that the pressure can equalise at any time.

The on-site drainage must be installed so that all water flowing out of the steam generator can flow away without blockage. Installation must be made using a pipe of at least 50 mm diameter (DN 50) and a sufficiently large drain trap. The drain trap can also be made using DN 50 bends if necessary.

The DN 50 pipe connection between steam generator and drain trap **must be vertical and have a length of at least 80 cm.**

Installation:

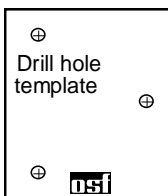

Please use the drill hole template included in delivery for the wall fixing. The steam generator may only be fixed to a suitable foundation with sufficient load-bearing capacity and temperature resistance. The SILVER STEAM steam generator must be installed protected against moisture in accordance with its protection class.



Electrical power supply / safety information:

The device power supply must be connected via a multi-pole main switch with a contact opening width of at least 3 mm and an earth fault circuit interrupter with $I_{FN} \leq 30\text{mA}$. Please observe the circuit diagram on the last page. **The device must be isolated before opening the housing. Electrical power supply connections, in addition to alignment and service work may only be carried out by approved electricians. The attached connection plan and the current relevant safety regulations must be observed.**

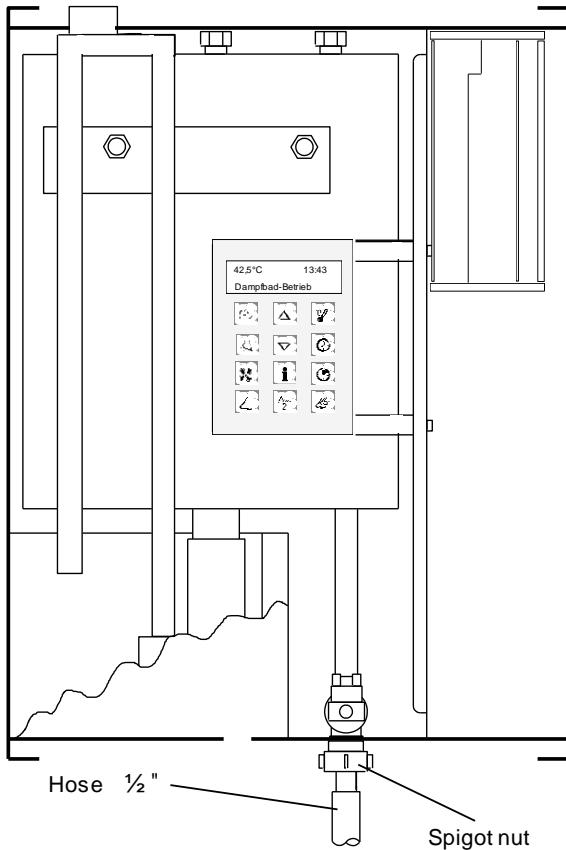

Connection to water supply

A pressure-resistant $\frac{1}{2}$ " washing machine connection hose with 90° angle connection and $R\frac{3}{4}$ " thread must be used for the water connection. This hose is then connected to the threaded connection on the solenoid valve using the spigot nut attached.

The water pressure may not fall below 2 bar and not exceed 5 bar (optimum: 3-4bar). If necessary, a pressure reducer and, if required, a filter must be integrated into the on-site installation. The water temperature may not exceed 30 °C.

You must observe all regulations issued by the local water supply company when making the water connection.

A fitting for connection with the water pipe is already fitted, which prevents water from the steam generator being fed backwards into the water pipe.

A fine filter must be installed on site.

Service information:

There is a sieve in the solenoid valve inlet. This sieve has the task of filtering out any dirt particles contained in the water, so that these particles do not cause any malfunctions in the device. If the steam generator water feed is prevented by a contaminated or blocked sieve, this results in triggering of the safety circuitry and cancelling of steam production. This sieve must be cleaned at regular intervals, especially after installation work to the water supply network.

Ventilation:

Never close off ventilation opening!

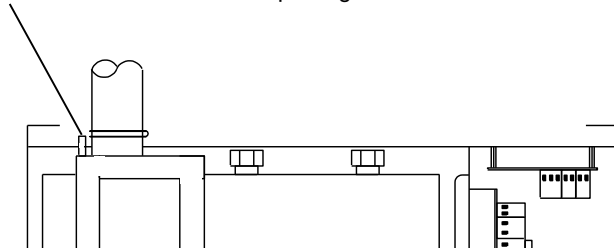

There is an opening in the top area of the left-hand stainless-steel pipe (see sketch) which is essential for ventilation of the system. This opening must never be closed off. If the opening is closed, device malfunctions are inevitable. If water emerges from this opening during operation, it is possible that the drainage pipe is not of sufficient diameter or is blocked.

The steam pipeline

Steam pipeline connections

The correct functioning of the steam bath device is dependent on proper steam distribution amongst other issues. The steam must arrive in the cubicle in a homogeneous state, without drops and unnecessary condensate. The location of steam entry into the cubicle must be selected so that the moist airflow is never directed onto people, lighting fittings, temperature sensors or other heat-sensitive surfaces before the steam has been completely integrated into the room air.

It is imperative that the steam hose supplied with the device is used to make the connection to the steam generator. This is fixed to the left-hand socket of the steam vessel using the attached steel band clamp (see sketch). **This steam hose may never be bent, kinked or damaged.** It must be routed vertically upwards and connects the steam vessel with the fixed copper pipe.

Installation of the steam pipeline

Fixed installation must be carried out using 35 mm copper pipe. This copper pipe must have a gradient of at least 5° towards the steam bath cubicle. Any condensate produced in the piping system must flow into the cubicle under gravity without interruption, and then flow into the drain. The drain in the cubicle must be located underneath the steam nozzle so that any hot condensate produced does not cause any damage.

The entire steam pipeline must be kept as short as possible and laid extremely carefully so that restrictions and kinks are avoided (observe bending radii)

In addition, condensate or water deposits must be avoided in the steam pipeline at all costs, because this would immediately lead to malfunctions and present an unnecessary safety risk.

The steam pipeline must be provided with good heat insulation

along its entire length. This insulation reduces the heating time required for the steam bath cubicle, reduces condensate formation and contributes considerably towards energy-saving.

When the steam generator is first taken into operation, the steam hose supplied with the device can smell a little. To reduce the smell as much as possible, the steam hose has been pre-aged in the works. It is possible that unavoidable signs of usage appear on the steam hose due to this pre-ageing process. These signs of usage do not affect the functional safety or reliability of the component.

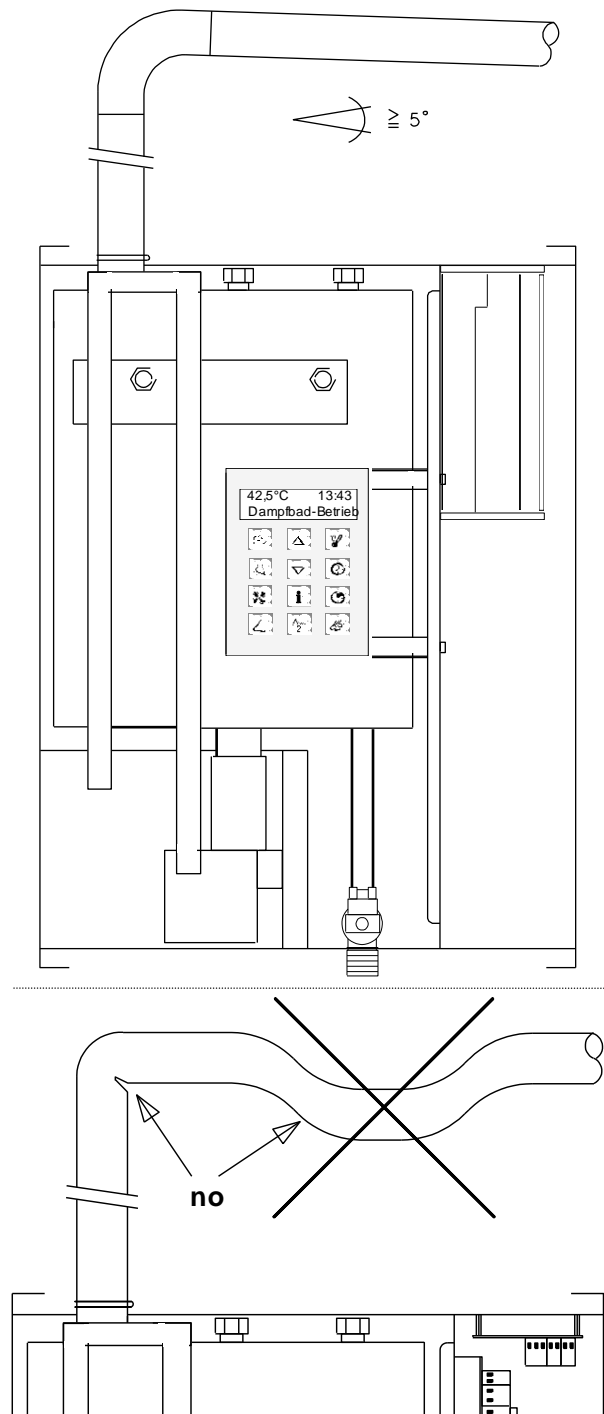

The **OSI** steam nozzles (set)

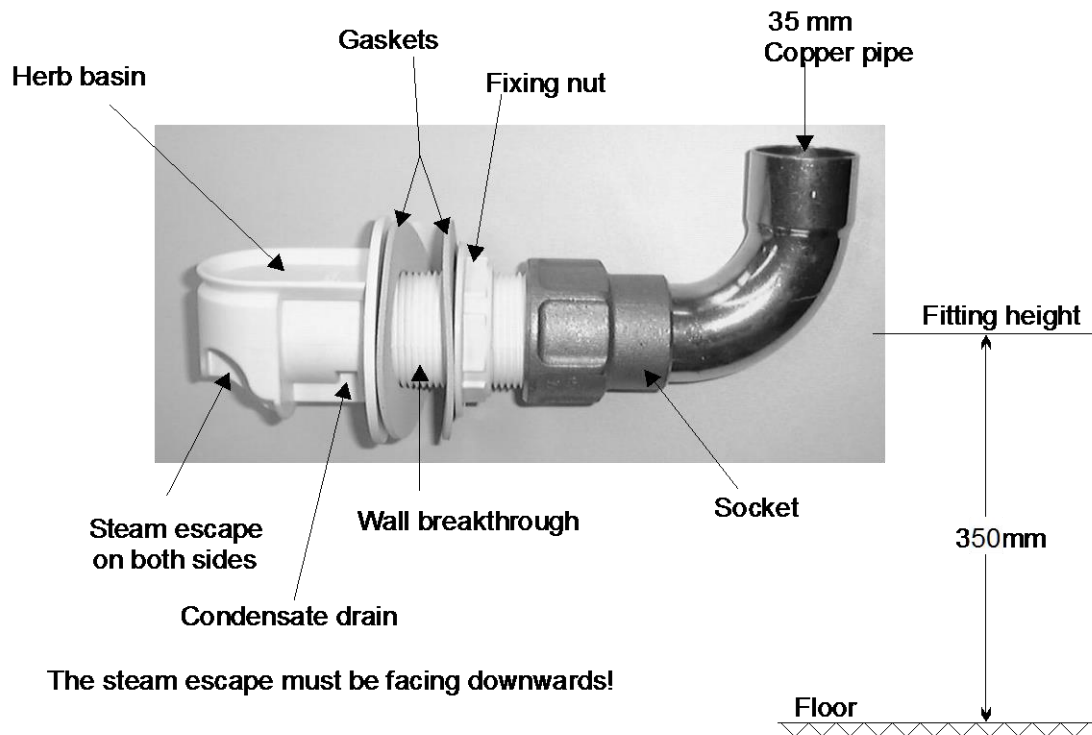

You must use a **OSI** special steam nozzle (set) with article number 2260401100 for steam entry into the cubicle. If this is not possible, and another type of steam entry is used, the opening diameter may not be less than 32 mm! The connection of one steam nozzle with several small openings is not permitted. The steam nozzle is fitted permanently at a height of around 35 cm above the floor. When installing, ensure that the steam or condensate water exiting does not cause any damage. The steam nozzle must be installed above the drain. If installation is carried out incorrectly, there is a scalding hazard. Please use the cover.

Herb basin

On the top of the **OSI** special steam nozzle, there is a small basin for solid fragrances (herbs). When producing steam, any herbs placed here are warmed and the fragrance is then distributed around the cubicle. **In order to avoid damage to the steam nozzle, liquid fragrances may not be placed in the basin. You may only use herbs which are known to be not damaging to health.**

Cover for **OSI** steam nozzle

You must fix a transparent cover with article number 1260401120 to prevent contact with the steam nozzle. This cover is made of transparent plastic. It is pushed over the 1 ¼" steam nozzle thread and fixed between the steam nozzle and the cubicle wall.

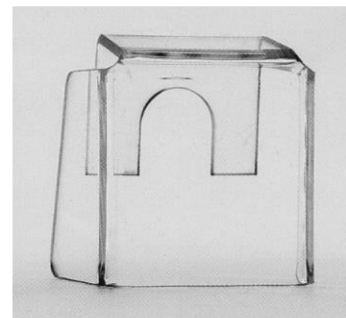

Temperature sensor installation

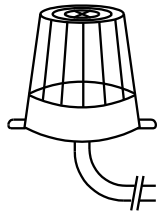

Installation:

The temperature sensor is fixed to the door at a height of 1.4 m in the steam bath cubicle. Please see the adjacent drawings for the arrangement.

Course of action:

- Drill a drill hole of diameter 8 mm for the sensor cable, not above the steam entry point.
- Guide the sensor cable from the inside of the cubicle into the drill hole.
- Fix the temperature sensor in front of the drill hole so that the drill hole is covered.
- Use corrosion-resistant screws for fixing (e.g. V4A).
- Seal off the drill hole (e.g. using silicon).
- Route the sensor cable as far as the steam generator and connect to terminals 10 & 11. The polarity of each cable is irrelevant.
- The temperature sensor is supplied with a cable of length 3 m as standard. If required, this can be lengthened to maximum 10 m (cross-section minimum 0.5mm²). **Avoid routing the sensor cable next to power cables to avoid possible interference.**

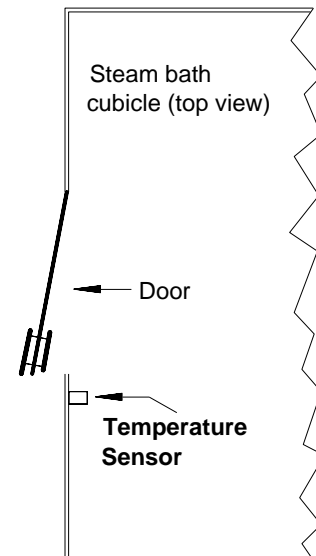
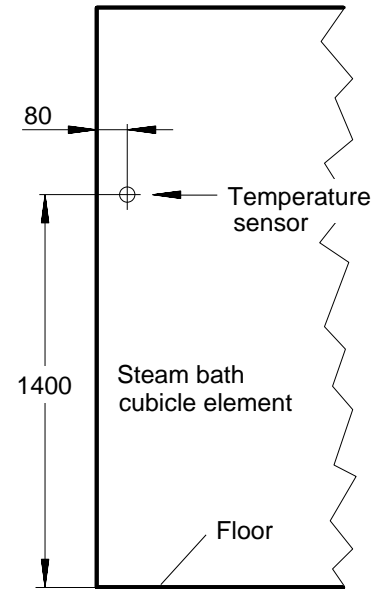

It is imperative for the function of the steam generator that both cables on the temperature sensor are connected with the appropriate steam generator connection terminals. A defective, non-connected or bypassed temperature sensor leads to immediate triggering of the safety circuitry, and therefore interrupts steam production. Please use the adjacent resistance table for carrying out any checks on the temperature sensor.

Temperature sensor

Temperature	Resistance
10°C	887Ω
20°C	961Ω
30°C	1039Ω
40°C	1120Ω

Balancing the temperature sensor

The temperature sensor and the control system electronics have been balanced. If the temperature sensor or control system electronics are replaced, the sensor must be balanced again by a qualified electrician.

Course of action:

1. Use a reference thermometer to measure the real temperature in the immediate vicinity of the temperature sensor.
2. The temperature range at the appropriate adjuster can be adjusted by 3k upwards or downwards using a small screwdriver.

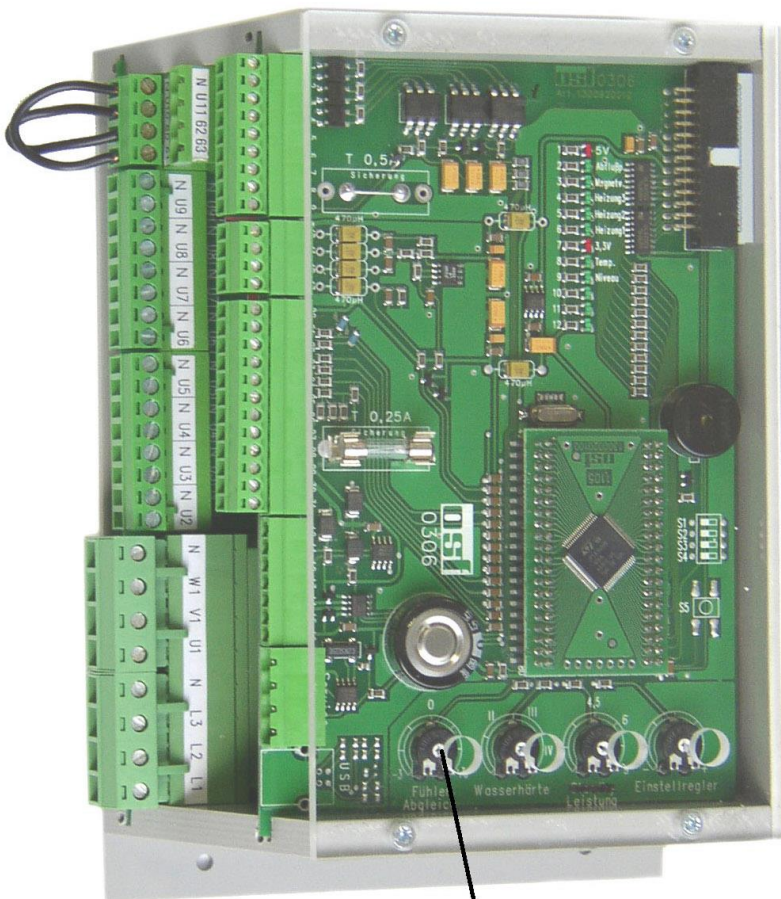

Adjuster temperature



Adjuster

Electronics housing with PCBs.



Cubicle lighting

The **nsi** "SILVERSTREAM" steam generator is provided with a transformer (optional) which provides the steam bath cubicle lighting with power. This transformer is VDE-approved and supplies low safety voltage of 11.5V. The lighting can be switched on or off using the "*Light*" key on the steam generator operating panel (see also above in text).

Electrical connection

Installation must be carried out using a sheathed cable with a core cross-section of at least 0.75 mm². The cable is connected directly to the transformer terminals (see adjacent sketch). **The lightbulb may not exceed 60 W at 11.5 V.**

Fusing

Fusing takes place using a slow-blow 5A device fuse (5 x 20). The fuse is located in the transformer terminal compartment.

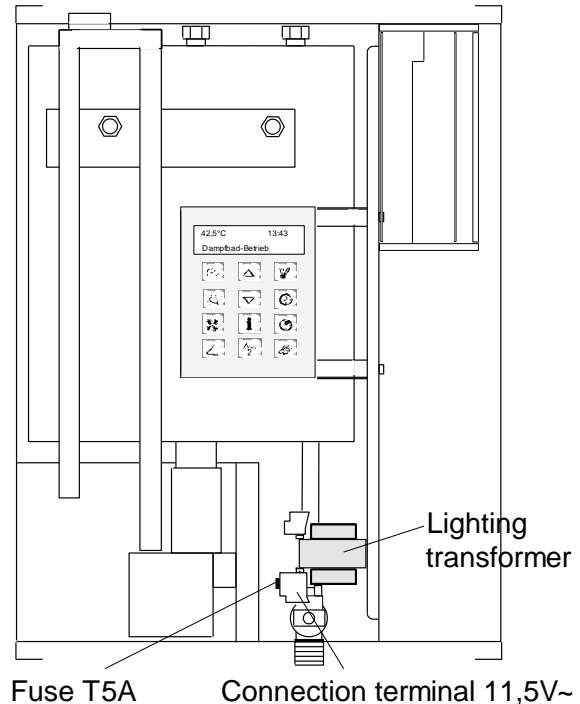

External transformer

In the case of steam generators without built-in transformers (basic version) there is a facility for installing a suitable transformer on site. This is connected to terminals *U6* and *N* (caution: 230V) on the bottom PCB. Switching the lighting on or off takes place using the "*Light*" key on the steam generator operating panel (see also "Displays and controls").



Winter operation

Even a steam generator which has been switched off and emptied using the rinse program always contains small quantities of residual water. The steam generator must always be stored in frost-free conditions to avoid damage caused by freezing water.

Decalcification

In order to achieve long service life and perfect functioning of the steam generator, the steam vessel must be regularly decalcified irrespective of the decalcification timer.

If this decalcification process is not carried out, the lime deposits will lead to malfunctions after a certain time. The timing of the individual decalcification processes is dependent on the hardness of the water and the length of service operation of the steam generator amongst other influences. The duration of decalcification is dependent on the preparations used, the temperature and the intensity of the lime deposits. The value stated here are intended as a guideline and do not have general applicability.

Course of action:

Before commencing decalcification, the emptied steam generator must be isolated from the power supply by switching off the main switch installed in situ.

The hexagonal brass screwed connection visible from above is removed using a suitable socket spanner.



Dissolve the contents of one sachet of **TSI decalcification agent in 9 litres of warm water.**

The decalcification agent is introduced into the steam vessel using a funnel.

After the steam vessel has been filled, reinstall the hexagonal brass screwed connection.

⇒  **Caution: do not lose the internal gasket!**

Caution: allow the decalcification agent to work overnight. Too short decalcification times are ineffective.



Completion of decalcification:

1. Ensure that the steam vessel, including the hexagonal brass screwed connection, is sealed!
2. Switch on the in situ main switch again.
3. Switch on the steam generator using the "Steam" key on the operating panel, which starts the rinse programme. ⇒ The steam vessel is emptied, rinsed out twice with tapwater and then refilled.
4. Once the steam vessel has been filled with water and the heater automatically switched on, switch the steam generator off using the "Steam" key on the operating panel, which starts the rinse program again.
5. The rinse program must be started at least twice to free the steam generator from all residues.
6. Reset Decalcification. See under "Decalcification "

Decalcification must be carried out after around 100 operating hours if the water is hard.

Safety information regarding **TSI** decalcification agent:

General:	remove soiled clothing.
after inhaling:	fresh air, medical help
after skin contact:	rinse off with plenty of water
after eye contact:	wash eyes out with eyelids open
after swallowing:	rinse out mouth and drink plenty of water

A safety data sheet for the **TSI** decalcification agent can be requested from your steam generator supplier.

Odour metering

The comfortable **ISI** "SILVER-STEAM" steam generator with integrated odour pump (optional) controls the odour input to the steam bath cubicle fully automatically, and therefore ensures a congenial and pleasant climate - the extra-special something for your steam bath.

The odour metering is switched on using the "Odour" key on the front of the steam generator. (See also page 2).

The intelligent **ISI** microprocessor control system activates the odour metering depending on the temperature in the steam bath cubicle. The fragrant metering only starts once the steam production has been switched on and the steam bath cubicle has been heated to at least 5 °C below the set temperature.

Please use only water-soluble and diluted fragrance essences which exclude any possible health hazards.

Odour intensity

Use this function to program the odour intensity. If you press the "Odour intensity" Key, the wording "Odour impulse" is shown in the display. The currently programmed impulse duration blinks top left in the display. The impulse length displayed can now be changed using the "Plus" or "Minus" keys. Increasing the impulse length results in longer operation of the fragrance metering pump and therefore an increase in fragrance intensity. **The value shown in the display is automatically saved.**

Impulse time in seconds (blinks)

15,0 s	5,0 m
odour-impulse	

Pause duration in minutes

Now press the "Odour intensity" key again, and the display will show the wording "Odour pause". The currently programmed pause duration blinks top right in the display. Press the "Plus" or "Minus" keys to change the pause duration displayed. Increasing the pause length results in a longer pause between odour injections and therefore reduction of odour intensity. **The time shown in the display is saved automatically.** Once the odour intensity has been programmed, press the "Odour intensity" key again to switch the display back to the "initial position". If not, the intelligent microprocessor control system switches the display back to the 10 seconds after the last time the "Plus", "Minus" or "Odour intensity" keys were pressed.

Impulse time in seconds

15,0 s	5,0 m
odour-pause	

Pause duration in minutes (blinks)

Bleeding the fragrance hose

After the steam generator has been started up, it takes a little time until the fragrance hose has been completely filled with fragrance. Fragrance injection only starts once the fragrance hose is completely filled with fragrance.

The steam generator offers the facility for controlling the fragrance pump manually in order to bleed the fragrance hose. To do this, press the following three keys simultaneously and keep them pressed until the hose is completely filled with fragrance.



Connecting the fragrance unit

The container for fragrance essences is fixed directly below the steam generator, and the hose connection should be kept as short as possible. The fragrance pump suction hose (left-hand hose) is introduced into the fragrance container so that the end of the hose is laid horizontally on the container floor. The container must have a ventilation opening.

Injection of fragrance essences take place in the vicinity of the steam nozzle directly into the steam pipeline. **The brass hose nipple included in delivery is introduced from above into a drill hole in the copper pipe and soldered.** The pressure pipe is laid between the steam generator (hose pump, right-hand hose) to the steam pipeline without kinks, and connected to the brass hose nipple. The hose should then be fixed with a cable clip.



Brass hose nipple

Caution:

fragrance essence must never be injected into the vertical steam pipeline above the steam generator or into the steam vessel!

Fragrance essence may not flow into the steam generator through the steam pipeline!

The hoses should be introduced into the steam generator from below.

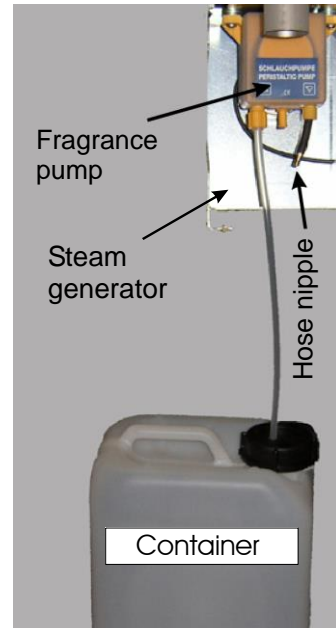

Hose bracket

Fragrance metering pump maintenance

The hose fitted to the fragrance metering pump is a wear part. If damaged, this hose should be replaced with an original spare part. **Since the steam generator needs to be opened to do this, this service work may only be carried out by an authorised electrician.** The hose should never be greased.

Course of action

1. Isolate steam generator!
2. Always empty the pump hose and hosing connection first. Otherwise, corrosive fragrance residues can cause eye or skin injuries when removing the pump hose. Wear protective goggles and protective gloves if necessary.
3. Once the pump housing cover has been removed, pull the hose bracket together with the pump hose forwards by rotating the rotor once.
4. Remove the old pump hose, and push the new pump hose onto the stub as far as the stop without twisting.
5. If the pump housing is moist or soiled due to discharge fragrance, remove the rotor and clean the pump housing.
6. Push the hose bracket into the pump housing.
7. Rotate the rotor again to introduce the hose into the track.
8. Refit the pump housing cover.
9. Carry out a function and safety check.

The fragrance pump hose is a wear part. We cannot give a guarantee of compatibility between the hose and all fragrances available on the market.

Troubleshooting checklist for malfunctions



Caution: Troubleshooting may only be carried out by an authorised electrician!

The  SILVER-STEAM steam generator is fitted with an intelligent microprocessor control system which is capable of recognising diverse malfunctions and displaying error messages.

These acoustic signals are declared as follows: l => long peep tone
s => short peep tone

Error message	Acoustic signal	Possible cause	Remedy
Power failure		Interruption to power supply	Press " <i>Steam</i> " key
Operating panel		Fuse defective	Replace fuse
M fault	s k s s	Water provision not correctly functioning	Clean sieve in "water feed" solenoid valve, or open water tap in feed pipe.
MB fault	s k s s	Interruption to water supply	Remedy fault in water supply After this, press " <i>Steam</i> " key
SN fault	s k k k	Temperature sensor not correctly connected	Check connection
S fault	s k k s	Temperature sensor defective or no originals sensor connected	Replace temperature sensor
SK fault	s k s k	Temperature sensor short-circuited	Check sensor and cables
P fault	s s k k	Drainage pump defective, calcified or mechanically blocked, or pump feed or drain blocked.	Remove calcification or blockage, replace pump if necessary, check drain
		Level sensor system calcified	Decalcify generator
FB fault	s s k k	Drainage pump probably blocked	Clean drainage pump
		Level sensor system calcified	Decalcify generator

Troubleshooting / pilot light

Indicator lamps 1

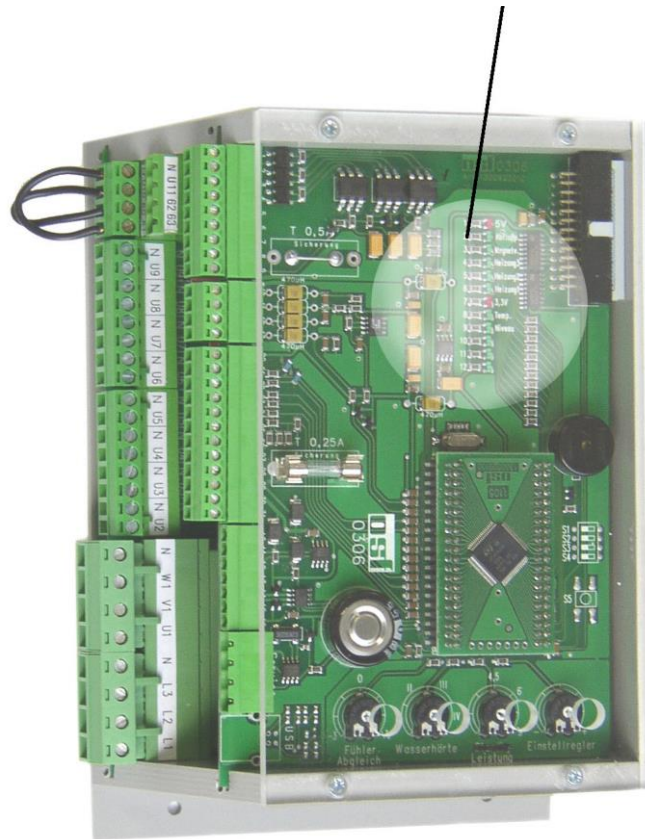

The controls electronics contains several pilot lights which help when carrying out function checks or troubleshooting.

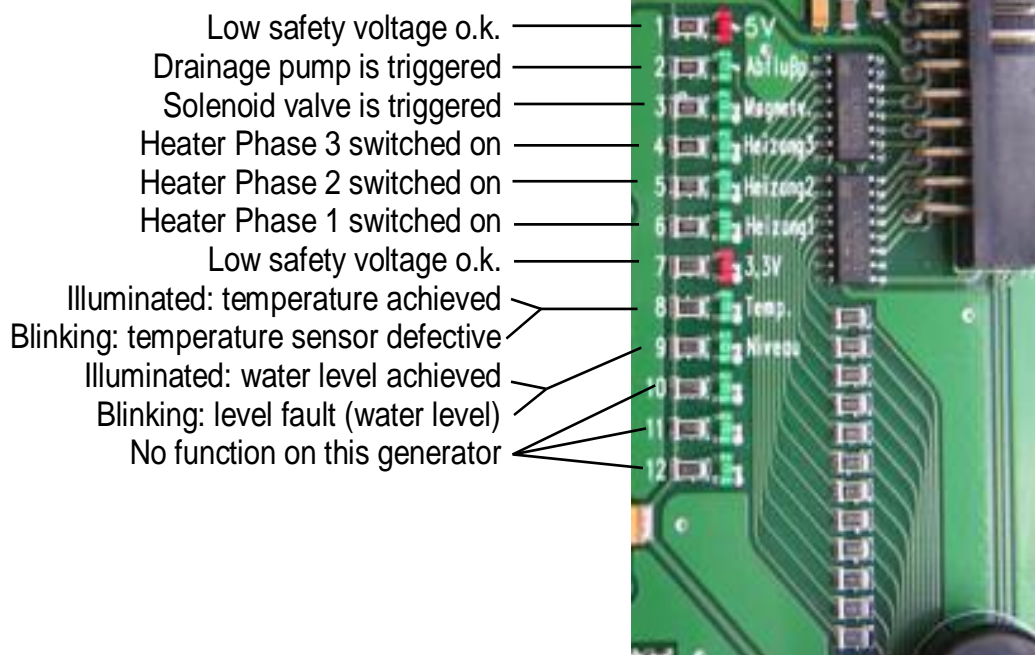

Service terminal

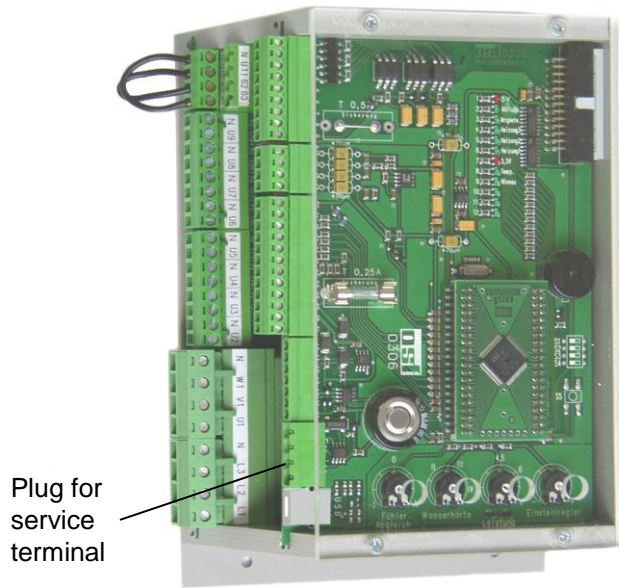

In order to optimally adapt the steam generator to various steam bath cubicles, and for ease of initial startup and troubleshooting, you can connect a **osf** service terminal to the control system electronics. Part No. 3010000900) The connecting plug is located on the top control system PCB. **Before opening the housing and plugging in the service terminal, you must ensure that the steam generator has been isolated from the mains!** Once the control system has been switched on, the service terminal display shows the first 4 lines of the diagnosis text, e.g.:

```
osf DG3 ver.01.10
N:9999 LUX 9,0kW
steam bath mode
set temp: 38,4°
```

Version
Serial number and type
Operating condition
Current cubicle temperature

Further lines can be called up using the Δ and ∇ keys. Values in the **top** sine can be changed by pressing the \downarrow key if necessary.

The following displays are possible:

<i>Set temp:</i>	Set temperature adjusted
<i>Tank temp:</i>	Water temperature in standby operation (not displayed for ass device types)
<i>Odour impulse:</i>	Impulse period set for fragrance injection in seconds.
<i>Odour pause:</i>	Pause length set for fragrance injection in seconds.
<i>Decalc Cyc:</i>	Decalcification cycle, dependent on water hardness adjusted
<i>StandbySwitch:</i>	This sine shows whether the standby function has been switched on or off.
<i>Remote switch:</i>	This sine shows whether the remote switch has been switched on or off.
<i>Level:</i>	These lines show information about the water level
<i>Possible texts :</i>	
<i>Empty</i>	Container is empty
<i>Full</i>	Water levels is at normal level
<i>Faust</i>	Level sensors have probably been exchanged in generators with plastic tank
<i>Overpress.</i>	Overpressure in vessel or counterpressure in steam pipeline



The following lines are used for manual activation of the output relay.

Level sensor in generator with metal tank

When the service terminal shows the wording *Fork sensor* in the **top** line, the level sensor can be switched on or off manually.

1. Once the  key has been pressed, the steam generator is switched off and the display shows the following:

Fork sensor: OFF
MANUAL OPERATION
can control
by hand



2. Use the  key to switch the level sensor on, and the  key to switch it off.
3. If you press the  key again, the normal diagnosis display appears and the steam generator continues to operate.

Drainage pump

When the service terminal shows the wording *Drainage pump* in the **top** line, the drainage pump can be switched on or off manually.

1. Once the  key has been pressed, the steam generator is switched off and the display shows the following:

Drainage pump OFF
MANUAL OPERATION
can control
by hand



2. Use the  key to switch the drainage pump on, and the  key to switch it off.
3. If you press the  key again, the normal diagnosis display appears and the steam generator continues to operate.

Water feed solenoid valve

When the service terminal shows the wording *Solenoid valve* in the **top** line, the solenoid valve can be switched on or off manually.

1. Once the  key has been pressed, the steam generator is switched off and the display shows the following:

Solenoid valve OFF
MANUAL OPERATION
can control
by hand



2. Use the  key to switch the solenoid valve on, and the  key to switch it off.
3. If you press the  key again, the normal diagnosis display appears and the steam generator continues to operate.

Fragrance pump

When the service terminal shows the wording *Fragrance pump* in the **top** line, the fragrance pump can be switched on or off manually.

1. Once the  key has been pressed, the steam generator is switched off and the display shows the following:

odour pump OFF
MANUAL OPERATION
can control
by hand



2. Use the  key to switch the fragrance pump on, and the  key to switch it off.
3. If you press the  key again, the normal diagnosis display appears and the steam generator continues to operate.

Light

When the service terminal shows the wording *Light* in the **top** sine, the cubicle lighting can be switched on or off manually.

1. Once the  key has been pressed, the steam generator is switched off and the display shows the following:

light: OFF
MANUAL OPERATION
can control
by hand



2. Use the  key to switch the cubicle lighting on, and the  key to switch it off.
3. If you press the  key again, the normal diagnosis display appears and the steam generator continues to operate.

Additional output Aux1

When the service terminal shows the wording *AUX1* in the **top** sine, the additional output AUX1 can be switched on or off manually.

1. Once the  key has been pressed, the steam generator is switched off and the display shows the following:

aux1: OFF
MANUAL OPERATION
can control
by hand

2. Use the  key to switch the additional output on, and the  key to switch it off.
3. If you press the  key again, the normal diagnosis display appears and the steam generator continues to operate.

Aux2



Additional output *AUX2* is only used by **USB1** service technicians

Exhaust fan

When the service terminal shows the wording *Exhaust* in the **top** sine, the exhaust fan can be switched on or off manually.

1. Once the  key has been pressed, the steam generator is switched off and the display shows the following:

exhaust: OFF
MANUAL OPERATION
can control
by hand

2. Use the  key to switch the exhaust fan on, and the  key to switch it off.



3. If you press the  key again, the normal diagnosis display appears and the steam generator continues to operate.

Feed air fan

When the service terminal shows the wording *Feed air* in the **top** sine, the feed air fan can be switched on or off manually.

1. Once the  key has been pressed, the steam generator is switched off and the display shows the following:

supply fan: OFF
MANUAL OPERATION
 can control
 by hand



2. Use the  key to switch the feed air fan on, and the  key to switch it off.
3. If you press the  key again, the normal diagnosis display appears and the steam generator continues to operate.

Submersible heater U1

If the wording *Submersible heater U1* is shown in the top sine of the service terminal display, and the vessel has been sufficiently filled with water, submersible heater U1 can be switched on or off manually:

1. Once the  key has been pressed, the steam generator is switched off and the display shows the following:

heater U1: OFF
MANUAL OPERATION
 can control
 by hand



2. Use the  key to switch submersible heater U1 on, and the  key to switch it off.
3. If you press the  key again, the normal diagnosis display appears and the steam generator continues to operate.

Submersible heater V1

If the wording *Submersible heater V1* is shown in the top sine of the service terminal display, and the vessel has been sufficiently filled with water, submersible heater V1 can be switched on or off manually:

1. Once the  key has been pressed, the steam generator is switched off and the display shows the following:

heater V1: OFF
MANUAL OPERATION
 can control
 by hand



2. Use the  key to switch submersible heater V1 on, and the  key to switch it off.
3. If you press the  key again, the normal diagnosis display appears and the steam generator continues to operate.

Submersible heater W1

If the wording *Submersible heater W1* is shown in the top sine of the service terminal display, and the vessel has been sufficiently filled with water, submersible heater W1 can be switched on or off manually:

1. Once the  key has been pressed, the steam generator is switched off and the display shows the following:

heater W1: OFF
MANUAL OPERATION
can control
by hand

2. Use the  key to switch submersible heater W1 on, and the  key to switch it off.
3. If you press the  key again, the normal diagnosis display appears and the steam generator continues to operate.

SteamHours



This sine shows the operating hours for steam production.

Casc Timer

When the wording *Calc Timer* is displayed in the **top** sine of the service terminal, the decalcification timer can be deleted.

1. Once the  key has been pressed, the steam generator is switched off and the display shows the following:

decalcify timer
can be
deleted with
arrow keys



2. Use the   key to delete the decalcification timer.
3. After this, the normal diagnosis display is shown and the steam generator continues operation.

Language

When the wording *Language* is shown in the **top** sine of the service terminal display, you can select the language for the service terminal:

1. Once the  key has been pressed, the steam generator is switched off and the display shows the following:

Language: DEU
Sprache wählen
language select

2. Use the  or  keys to select the language.
3. If you press the  key again, the normal diagnosis display appears and the steam generator continues to operate.

Calibrate temp.

This function can only be used by **051** service technicians.

Diagnosis

This function can only be used by **051** service technicians.

Circuit diagram “SILVER-STEAM luxury” steam-generator

PCB top

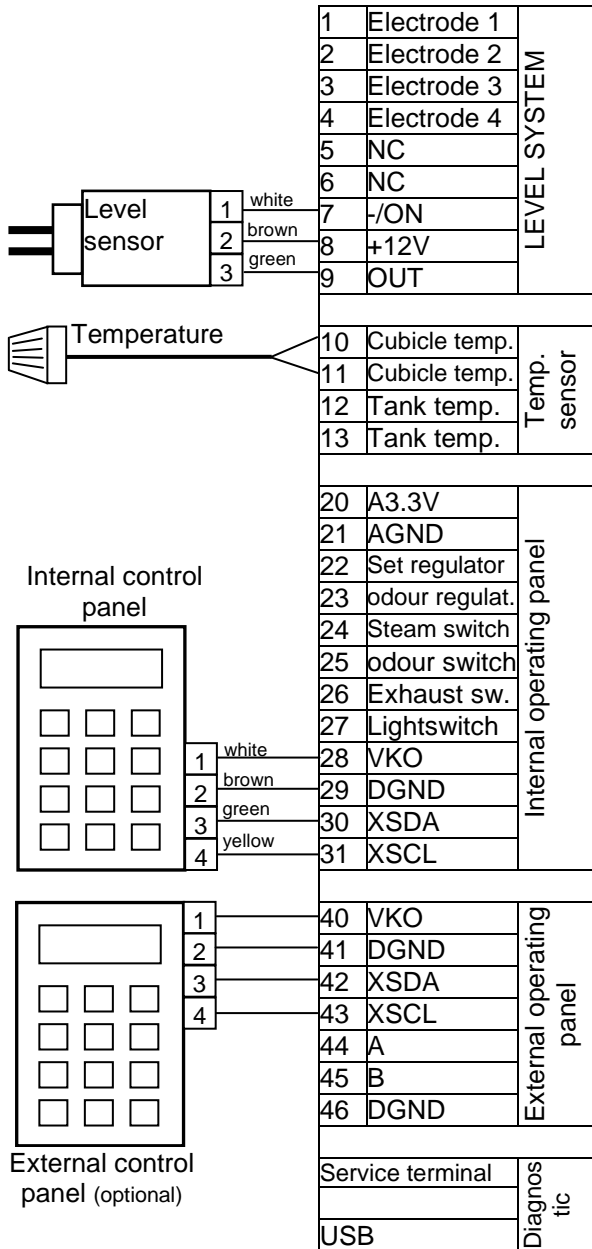

Circuit boards bottom

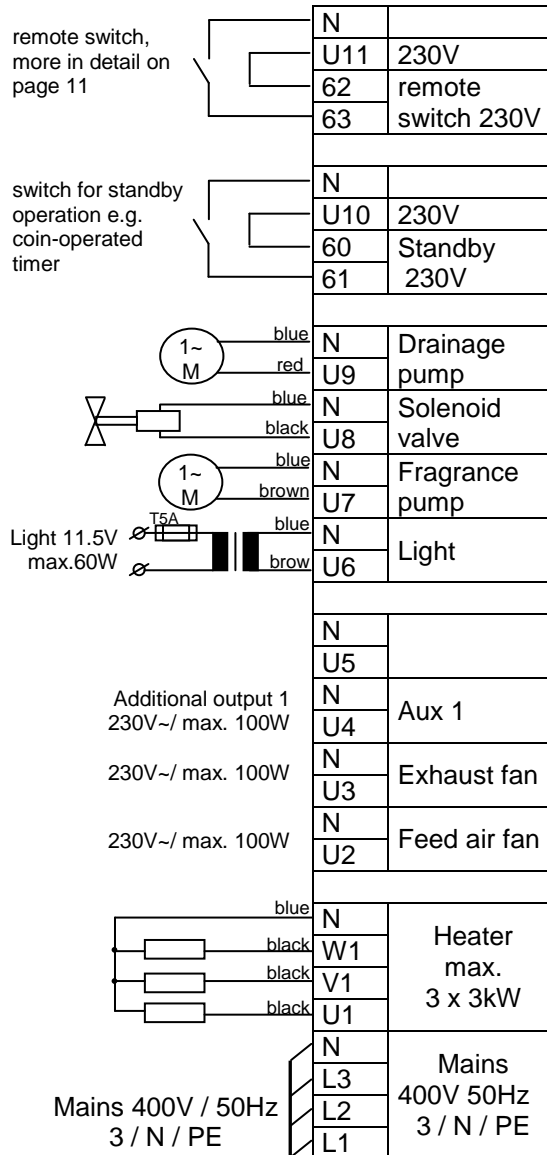

Wear parts

The following components are wear parts for which **no** guarantee can be provided.
Fragrance pump hose, heating element, drainage pump.

We hope you have a lot of enjoyment and relaxation in your steam bath

Subject to alterations!